

GCT 3-14 +

GCT



GEHL®

Capacities		Metric	Imperial
Max. capacity	Q	1500 kg	3307 lb
Max. lifting height	h3	4.30 m	14 ft 1 in
Max. outreach		2.62 m	8 ft 7 in
Reach at max. height		1 m	3 ft 3 in
Breakout force with bucket		1880 daN	1880 daN
Weight and dimensions			
Shipping mass (min. / max.)		2700 kg / 2900 kg	5952 lb / 6393 lb
Ground clearance	m4	0.29 m	11 in
Wheelbase	y	2.13 m	7 ft
Overall length to carriage (with hitch)	l11	3.47 m	11 ft 5 in
Front overhang		0.77 m	2 ft 6 in
Overall width	b1	1.49 m	4 ft 11 in
Overall cab width	b4	0.66 m	2 ft 2 in
Overall height	h17	1.92 m	6 ft 4 in
Tilt-down angle	a5	116 °	116 °
Tilt-up angle	a4	23 °	23 °
External turning radius (over tyres)	Wa1	2.62 m	8 ft 7 in
Performances			
Lifting		8.80 s	8.80 s
Lowering		7 s	7 s
Extension		6.40 s	6.40 s
Retraction		4.30 s	4.30 s
Crowd		3.40 s	3.40 s
Dump		2.60 s	2.60 s
Engine			
Engine brand		Yanmar	Yanmar
Engine norm		Stage V / Tier 4 Final	Stage V / Tier 4 Final
Engine model		3TNV88C-DMU	3TNV88C-DMU
Number of cylinders - Capacity of cylinders		3 - 1642 cm ³	3 - 100 in ³
I.C. Engine power rating / Power (kW)		35.10 Hp / 26.20 kW	35.10 Hp / 26 kW
Max. torque / Engine rotation		105 Nm @1950 rpm	77 ft/lbs @1950 rpm
Drawbar pull (Laden)		2000 daN	2000 daN
Reversible fan		Option	Option
Engine cooling system		3 radiators (water + hydraulic oil + fuel)	3 radiators (water + hydraulic oil + fuel)
Transmission			
Transmission type		Hydrostatic	Hydrostatic
Number of gears (forward / reverse)		2 / 2	2 / 2
Max. travel speed (may vary according to applicable regulations)		25 km/h	16 mi/h
Differential lock		Limited slip differential on front and rear axles	Limited slip differential on front and rear axles
Parking brake		Automatic negative parking brake	Automatic negative parking brake
Service brake		Hydraulic servo brake	Hydraulic servo brake
Hydraulics			
Hydraulic pump type		Gear pump	Gear pump
Hydraulic flow - Pressure		48 l/min - 235 bar	13 US gpm - 3408 PSI
Flow sharing distributor		Standard	Standard
Tank capacities			
Hydraulic oil		39 l	10 US gal
Fuel tank		35 l	9 US gal
Noise and vibration			
Noise at driving position (LpA) tested following NF EN 12053 norm		76 dB	76 dB
Environmental noise (LWA)		104 dB	104 dB
Vibration to whole hand/arm		< 2.50 m/s ²	< 2.50 m/s ²
Miscellaneous			
Safety cab homologation		Cabin ROPS - FOPS Level 1	Cabin ROPS - FOPS Level 1
Controls		Joystick	Joystick

GCT 3-14 + - Dimensional drawing

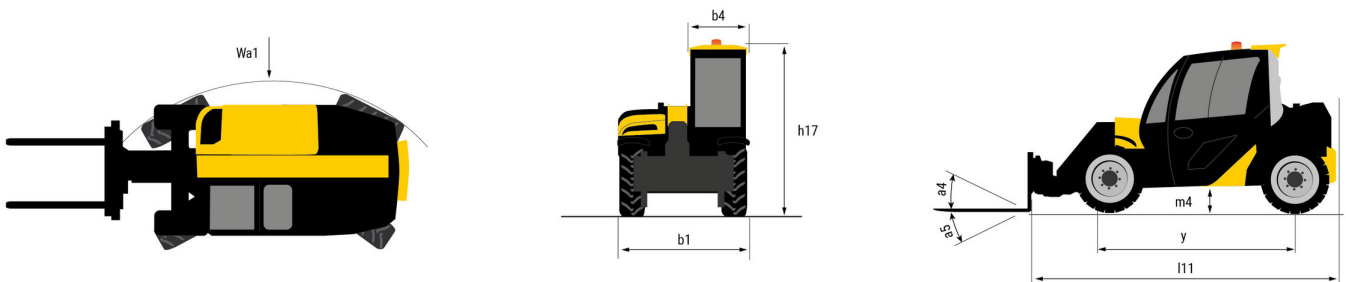

GCT 3-14 + - Load chart

Machine on tyres with forks Metric

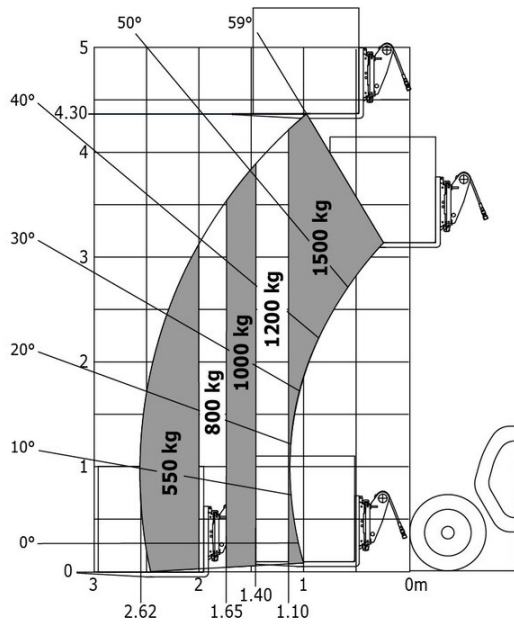

Machine on tyres with forks Imperial

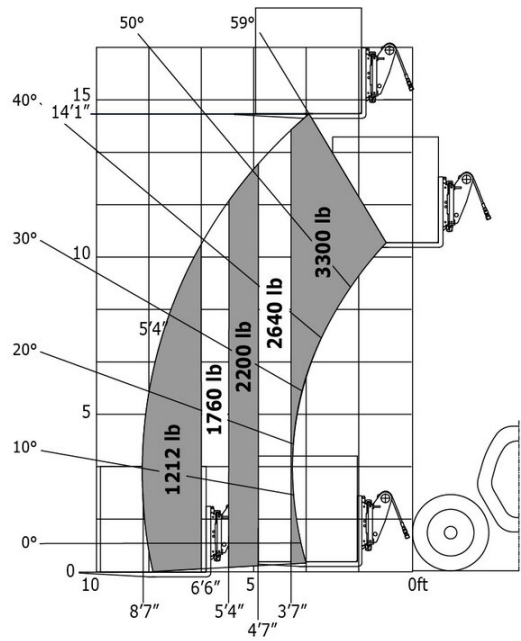



GEHL®

Siège Social
P.O. Box 179 - One Gehl Way - West Bend, WI, USA 53095
Tel: (262) 334-9461 - Fax: (262) 338-7517
www.gehl.com



This brochure describes versions and configuration options for Gehl products which may be fitted with different equipment. The equipment described in this brochure may be standard, optional or not available depending on version. Gehl reserves the right to change the specifications shown and described at any time and without prior warning. The manufacturer is not liable for the specifications given. For more information, contact your Gehl dealer. Non-contractual document. Product descriptions may differ from actual products. List of specifications is not comprehensive. The logos and visual identity of the company are the property of Gehl and may not be used without authorization. All rights reserved. The photos and diagrams contained in this brochure are provided for information only.

MANITOU EQUIPMENT AMERICAS, LLC - Limited company with board of directors - Share capital: 39,668,399 euros - 857 802 508 RCS West Bend